

FRQ5S-4/10/16A

Frequency inverter with sine filter for 3 ~ fans

Operating Instructions



Speed controller with 5-step switch for presetting the fan speed

Software version: D2732A from Version 1.05

Content

- 1 General notes 4**
 - 1.1 Structure of the operating instructions 4
 - 1.2 Target group 4
 - 1.3 Exclusion of liability 4
 - 1.4 Copyright 4

- 2 Safety instructions 4**
 - 2.1 Intended use 5
 - 2.2 Explanations of symbols 5
 - 2.3 Product safety 5
 - 2.4 Requirements placed on the personnel / due diligence 6
 - 2.5 Start-up and during operation 6
 - 2.6 Working on device / Hazards through “residual voltage” 6
 - 2.7 Modifications / interventions in the device 7
 - 2.8 Operator’s obligation of diligence 7
 - 2.9 Employment of external personnel 8

- 3 Product overview 8**
 - 3.1 Operational area 8
 - 3.2 Functional description 8
 - 3.3 Maintenance 9
 - 3.4 Transport 9
 - 3.5 Storage 9
 - 3.6 Disposal / recycling 9

- 4 Mounting 10**
 - 4.1 General notes 10
 - 4.2 Minimum space requirement 10
 - 4.3 Outdoor installation 11
 - 4.4 Installation location for agriculture 11
 - 4.5 Temperature influences during commissioning 11

- 5 Electrical installation 11**
 - 5.1 Safety precautions 11
 - 5.2 EMC-compatible installation 12
 - 5.2.1 Motor cable 12
 - 5.2.2 Control cables 12

5.2.3	Harmonics current for devices ≤ 16 A	12
5.3	Mains connection	12
5.3.1	Line voltage	12
5.3.2	Required quality attributes for the mains voltage	13
5.3.3	Leakage current, securely attached, protective earth conductor	13
5.4	Residual-current-operated protective device	13
5.5	Inverter output	13
5.5.1	Motor connection	13
5.5.2	Disconnection between controller and motor (repair switch)	13
5.5.3	U/f-characteristic curve	14
5.6	Motor protection	15
5.7	Voltage supply for external devices (+24V, GND)	16
5.8	Enable, Device ON / OFF (Digital In 1 = D1)	16
5.9	Relay outputs (K1)	16
5.10	Bypass circuit	16
5.11	Potential at control voltage connections	16
6	Start-up	17
6.1	Prerequisites for commissioning	17
7	Diagnostics / Faults	17
8	Enclosure	21
8.1	Technical data	21
8.1.1	Max. load dependent on ambient temperature and line voltage.	23
8.2	Connection diagram	24
8.2.1	Connection suggestion for several motors with motor protection unit type STDT	25
8.3	Dimensions [mm]	25
8.4	Manufacturer reference	26

1 General notes

1.1 Structure of the operating instructions

Before installation and start-up, read this manual carefully to ensure correct use! We emphasize that these operating instructions apply to specific units only, and are in no way valid for the complete system!

Use these operating instructions to work safely with and on the device. They contain safety instructions that must be complied with as well as information that is required for failure-free operation of the device.

Keep these operating instructions together with the device. It must be ensured that all persons that are to work on the device can refer to the operating instructions at any time. Keep the operating instructions for continued use. They must be passed-on to all successive owners, users and final customers.

1.2 Target group

The operating instructions address persons entrusted with planning, installation, commissioning and maintenance and servicing and who have the corresponding qualifications and skills for their job.

1.3 Exclusion of liability

Concurrence between the contents of these operating instructions and the described hardware and software in the device has been examined. It is still possible that non-compliances exist; no guarantee is assumed for complete conformity. To allow for future developments, construction methods and technical data given are subject to alteration. We do not accept any liability for possible errors or omissions in the information contained in data, illustrations or drawings provided.

We accept no liability for damage caused by misuse, incorrect use, improper use or as a consequence of unauthorized repairs or modifications.

1.4 Copyright

These operating instructions contain copyright protected information. The operating instructions may be neither completely nor partially photocopied, reproduced, translated or put on data medium without previous explicit consent. Infringements are liable for damages. All rights reserved, including those that arise through patent issue or registration on a utility model.

2 Safety instructions

This chapter contains instructions to prevent personal injury and property damage. These instructions do not lay claim to completeness. In case of questions and problems, please consult our company technicians.

2.1 Intended use

The equipment is to be used solely for the purposes specified and confirmed in the order. Other uses which do not coincide with, or which exceed those specified will be deemed unauthorised unless contractually agreed. Damages resulting from such unauthorised uses will not be the liability of the manufacturer. The user will assume sole liability.

Reading these operating instructions and complying with all contained instructions - especially the safety notifications contained therein - are considered part of intended use. To consider is also the manual of attached components. Not the manufacturer, rather the operator of the device is liable for any personal harm or material damage arising from non-intended use!

2.2 Explanations of symbols

Safety instructions are highlighted with warning triangles and are depicted according to the degree of hazard as follows.

	<p>Attention! General hazardous area. Death or severe injury or significant property damage can occur if the corresponding precautions are not taken!</p>
	<p>Danger due to electric current Danger by dangerous, electric voltage! Death or severe injury can occur if the corresponding precautions are not taken!</p>
	<p>Information Important additional information and advice for user.</p>

2.3 Product safety

The device conforms to the state of the art at the time of delivery and is fundamentally considered to be reliable. The device and its accessories must only be used in a flawless condition and installed and operated in compliance with the assembly instructions and/or operating instructions. Operating outside the device's technical specifications (name plate and attachment / technical data) can lead to a defect in the device and additional damage!

In the case of a malfunction or a failure of the equipment check all functions with alarms in order to prevent injury to persons or property. Note possibility of back-up operation. If used in intensive animal environments, any malfunctions in the air supply must be detected as soon as possible to prevent the development of a life-threatening situation for the animals. The design and installation of the system must comply with local regulations and directives. In Germany these include DIN VDE 0100, the animal protection and the keeping of working animals ordinance and the pig-keeping ordinance etc. Also note the instructions of AEL, DLG, VdS.

2.4 Requirements placed on the personnel / due diligence

Persons entrusted with the planning, installation, commissioning and maintenance and servicing in connection with the frequency inverter must have the corresponding qualifications and skills for these jobs.

In addition, they must be knowledgeable about the safety regulations, EU directives, rules for the prevention of accidents and the corresponding national as well as regional and in-house regulations. Personnel to be trained or instructed and apprentices are only permitted to work on the device under the supervision of an experienced person. This also applies to personnel undergoing general training. Comply with the legal minimum age.

This device is not intended to be used by people (including children) who have restricted mental, sensory or intellectual abilities or who have a lack of experience and/or knowledge.

2.5 Start-up and during operation



Attention!

- During commissioning, unexpected and hazardous conditions can arise in the entire installation due to defective adjustments, defective components or incorrect electrical connections. Remove all persons and objects from the hazardous area.
- During operation, the device must be closed or installed in a control cabinet. Fuses may only be replaced by new ones and must not be repaired or bypassed. The data for the maximum line fuse are to be considered absolutely (☞ Technical data). Use only fuses specified in schematic diagrams.
- Any faults detected in the electric system/modules/operating equipment must be corrected immediately. If these faults are not corrected, the device/system is potentially very dangerous. The device/system must therefore not be operated when it is faulty.
- Pay attention to smooth, low vibration running of the motor/fan, the appropriate instructions in the drive documentation must be observed!

2.6 Working on device / Hazards through “residual voltage”



Information

Mounting, electrical connection, and start-up operation may only be carried out by an electrical specialist in accordance with electrotechnical regulations (e.g. EN 50110 or EN 60204)!



Danger due to electric current

- It is generally forbidden to carry out work on electrical live parts. Protection class of the device when open is IP00! It is possible to touch hazardous voltages directly.
- The safe isolation from the supply must be checked using a **two-pole** voltage detector.
- Even after disconnecting the mains voltage, life-threatening charges can appear between the protective ground “PE” and the mains connection.
- The protective earth is conducting high discharge currents (dependent on the switching frequency, current-source voltage and motor capacity). Earthing in compliance with EN specifications shall therefore be observed even for testing and trial conditions (EN 50 178, Art. 5.2.11). Without earthing, dangerous voltages can be present on the motor housing.

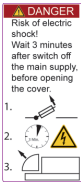

Waiting period of at least 3 minutes!

Through use of capacitors, danger of death exists even after switching off the device through directly touching the energized parts or due to parts that have become energized due to faults.

It is only permitted to remove the housing cover after waiting for 3 minutes once the line supply cable has been shut down. Should measurement or adjustment work be unavoidable on the opened unit while still powered, then this may only be performed by qualified personnel acquainted with the thereby associated hazards.



Attention!

Automatically restart after a power failure or mains disconnection!

2.7 Modifications / interventions in the device



Attention!

For reasons of safety, no unauthorized interventions or modifications may be made on the device. All planned modifications must be authorized by the manufacturer in writing.

Only use the manufacturer's original spare parts / wearing parts / accessories. These parts are specially designed for this device. If parts from other sources are used, there is no guarantee that they are designed and produced for the proper loads and with the required level of safety.

Parts and special equipment not supplied by the manufacturer are not approved for use.

2.8 Operator's obligation of diligence

- The contractor or owner must also ensure that the electric systems and equipment are operated and maintained in accordance with electro-technical regulations.
- The owner is obliged to ensure that the device is operated in perfect working order only.
- The device may only be used as intended (☞ “Application”).

- You must periodically examine the safety equipment for their properly functioning condition.
- The assembly instructions and/or operating instructions are always readily available at the location where the device is being used, are complete and are in legible condition.
- These persons are regularly instructed in all applicable questions regarding occupational safety and environmental protection and are knowledgeable regarding the assembly instructions and/or operating instructions and, especially, are familiar with the safety instructions contained therein.
- All safety and warning notices attached to the device are never removed and remain legible.

2.9 Employment of external personnel

Maintenance and service work are frequently carried out by external employees who often do not recognize the specific situations and the thus resulting dangers. These persons must be comprehensively informed about the hazards in their area of activity. You must monitor their working methods in order to intervene in good time if necessary.

3 Product overview

3.1 Operational area

Frequency inverter designed for a stepless control of fans without additional (electromagnetic) motor noise.

By using the integrated all-pole effective Sine filter (phase to phase and phase to ground), an absolute parallel control of fans without risk of damage for motors is possible. Screened motor cables are not required!

Only suitable for drives with low set-off torque (e.g.: fans or pumps).

3.2 Functional description

The frequency inverters generate their 3~ output with variable voltage and frequency from the three-phase mains on the input.

The devices are constructed in accordance with the general requirement in DIN EN 61800-2 for Adjustable speed electrical power systems and is intended for one-quadrant drives.

The fan speed is preset with the 5-step switch.

Step	Output frequency *
0	0 Hz
1	10 Hz
2	20 Hz
3	30 Hz
4	40 Hz
5	50 Hz

Direct switching from step "0" to step "5" or from step "5" to step "0" is not possible!

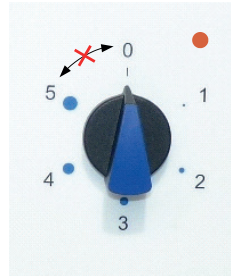

23.05.2013
v_5_step_icons_basic_sa_vsd

* The output frequency can be adapted by an internal potentiometer if necessary (⚡ inverter output: U/f-characteristic curve).



Danger due to electric current

In step "0" the frequency inverter is not switched off electrically but only no speed preset signal applied (= 0 V).

3.3 Maintenance

The device must be checked for soiling and, if necessary, cleaned in periodic intervals.

3.4 Transport

- The device is packed ex factory to suit the transport method previously agreed.
- Always use the original packaging materials when transporting the device.
- Avoid shocks and impacts to the device during the transport.
- During manual handling the human lifting and carrying restrictions must be observed and adhered to.

3.5 Storage

- The device must be stored in its original packaging in a dry and weather-proof room.
- Avoid exposure to extreme heat and cold.
- Avoid prolonged storage; we recommend a maximum of one year (consult the manufacturer before starting if stored for longer).

3.6 Disposal / recycling



Disposal must be carried out professionally and environmentally friendly in accordance with the legal stipulations.

4 Mounting

4.1 General notes

**Attention!**

The following points must be complied with during the mechanical installation to avoid causing a defect in the device due to assembly errors or environmental influences:

- Before installation remove the device from the packing and check for any possible shipping damage!
- Assemble the device on a clean and stable base. Do not distort during assembly! Use the appropriate mounting devices for proper installation of the unit!
- A mounting on vibrating base is not permissible, if no data to the vibration strength is made (☞ Technical data)!
- When mounted onto lightweight walls, there must be no impermissibly high vibrations or shock loads. Any banging shut of doors that are integrated into these lightweight walls, can result in extremely high shock loads. Therefore, we advise you to decouple the devices from the wall.
- Do not allow drilling chips, screws and other foreign bodies to reach the device interior!
- Maintain the stated minimum clearances to ensure unobstructed cooling- air feed as well as unobstructed outgoing air discharge (☞ minimum space requirement)!
- The device should be installed in a location where it will not be disturbed, but at the same time can be easily accessed!
- Depending on the housing model cut off necessary cable inlets respectively to the cable diameter. Or alternative use cable inlet for cable glands. Metal sheet housings are supplied with stoppers. Any cable ducts openings not used must be sealed!
- Care must be taken to avoid direct radiation from the sun!
- The device is designed for vertical installation (cable inlet down). A horizontal or reclined installation is only permissible after technical release of the manufacturer!
- Be sure to observe proper heat dissipation (☞ Technical data, heat dissipation).

4.2 Minimum space requirement

In order to ensure sufficient ventilation of the device, clearance on all sides of at least 50 mm has to be maintained to the housing walls, switch cabinet doors, wiring ducts, etc. The same clearance applies to the installation of several devices next to each other. When installing several devices on top of each other, the danger of reciprocal heating exists. This layout is only then permissible when the air suctioned from the upper unit does not become warmer than the permissible ambient temperature (☞ Technical data). I.e., a correspondingly larger clearance or thermal shielding is required.

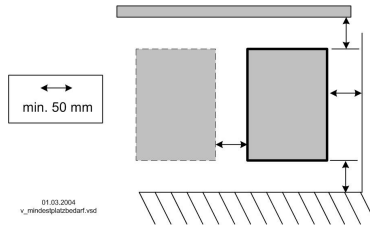

4.3 Outdoor installation

Outdoor installation is possible up to $-20\text{ }^{\circ}\text{C}$ when the controller supply is not switched off. Installation must be protected from the effects of weather as much as possible, including protection from direct sunlight!

4.4 Installation location for agriculture

In order to avoid damage caused by ammoniac vapours, the controller shall not be installed in the stable, but rather in an outhouse wherever possible.

4.5 Temperature influences during commissioning

Avoid condensation in the controller and functional faults attributable to condensation by storing the controller at room temperature!

5 Electrical installation

5.1 Safety precautions



Danger due to electric current

- Work on electric components may only be carried out by trained electricians or by persons instructed in electricity under the supervision of an electrician in accordance with electrical engineering regulations.
- The 5 electrical safety rules must be observed!
- It is forbidden to carry out work on electrically live parts. Even after disconnection, the dc-link is still live. Always wait at least 3 minutes.
- Other measures may be necessary to achieve safe electrical isolation.
- A second person must always be present when working on energized parts or lines who disconnects in case of emergency.
- Inspect electrical equipment periodically: retighten loose connections – immediately replace damaged lines and cables.
- Always keep switch cabinets and all electrical supply facilities locked. Access is only allowed for authorized persons using a key or special tool.
- Operating the device with the housing cover removed is prohibited because energized, exposed parts are present inside the device. Disregarding this regulation can lead to severe personal injury.

- **For metal cable inlets the necessary protective earth connection to the bottom of the housing is made by screws. The device may only be started up when these screws are fitted properly.**
- The device owner is responsible for the EMC of the entire plant according to the locally applicable standards.
- **Never clean electrical equipment with water or similar liquids.**

**Information**

The respective connections are represented in the enclosure of this manual (☞ Connection diagram)!

5.2 EMC-compatible installation

5.2.1 Motor cable

The applicable standard for interference emissions is EN 61000-6-3. Compliance with this standard is achieved through the use of an unscreened motor feed cable.

5.2.2 Control cables

Pay attention to sufficient distance from powerlines and motor wires to prevent interferences. The control cable may not be longer than 30 m. Screened control cables must be used when the cable length is longer than 20 m. When using a shielded cable connect the shielding to one side only, i.e. only to the control unit with the protective ground (keep cable short and with as little inductance as possible!).

5.2.3 Harmonics current for devices ≤ 16 A

According to EN 61000-3-2 these devices are to be classified as “professional” devices. The application is therefore limited to use by trade, certain vocations or industries. Connection to a low voltage supply (public networks) is allowed insofar as this has been clarified with the respective energy supply company responsible.

5.3 Mains connection

5.3.1 Line voltage

Power from the mains is connected to terminals: PE, L1, L2, L3. Here, it must be strictly observed that the mains voltage lies within the allowable tolerance specifications (☞ Technical data and nameplate affixed to the side).



**Danger due to electric current
Not suitable for IT system!**

5.3.2 Required quality attributes for the mains voltage



Danger due to electric current

The mains voltage must comply with the EN 50160 quality characteristics and the defined standard voltages in IEC 60038!

5.3.3 Leakage current, securely attached, protective earth conductor



Danger due to electric current

The maximum leakage current depends on the type of device and the connected mains voltage (☞ Technical Data). With regard to fixed connection and the type of PE conductor connection, the specification for the leakage current must be observed under consideration of the locally valid standards (for Europe☞ EN 50178 Section 5.2.11 or 5.3.2.1 etc.).

Minimum cross-section for PE conductor for fixed connection = 1.5 mm²!

5.4 Residual-current-operated protective device



Danger due to electric current

For an installation of r.c.d. protection, it shall be observed that this must be of “universal-current sensitivity” (Type B). In accordance with EN 50 178, Section. 5.2. other types of current-operated protective devices may not be used. To ensure as high a degree of reliability as possible, we recommend a tripping current of 300 mA.

5.5 Inverter output

5.5.1 Motor connection

The motor leads are connected to the terminals: PE, U, V, W. Several fans can be connected to the controller-the maximum total current of all motors must not exceed the current rating for the controller.



Information

- It is recommended that a separate motor protection unit be foreseen for each fan.
- For motors with thermistors “TP” (PTC thermistor) e.g. type U-EK230E
- For motors with thermostats “TB” (thermal contacts) e.g. type STDT16 or AWE-SK (☞ Enclosure: Circuit suggestion for several motors with motor protection unit type STDT.)

5.5.2 Disconnection between controller and motor (repair switch)

Ideally, a repair switch should be installed **before the controller** (supply line disconnect).

In the case of complete disconnection (entire load) after the controller, the enable (controller OFF / ON) must be disconnected simultaneously. I.e., an additional control contact is needed. Switching on the motor while simultaneously issuing the enable (ON) achieves secure energizing with low saturation of the controller.



Attention!

When switching on the motor plus existing release: under certain circumstances, this can occur under full modulation of the controller.

5.5.3 U/f-characteristic curve

A control signal for setting the output frequency is switched to the analog input of the device by the 5-step switch (0 - 10 V $\hat{=}$ 0 - 50 Hz).

Diagram setting signal and U/f curve (quadratic)

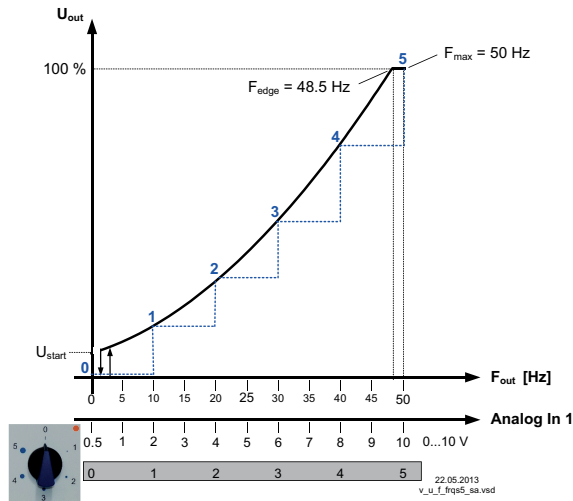

Analog In: Speed preset signal by 5-step switch

Fout: Output frequency

Uout: Output voltage

Ustart: Start-up voltage

Foff: Shutdown Freq.

Fedge: Edgefrequency

Fmax: Maximum frequency

Potentiometer for step adaptation

The device operates with the respective possible maximum frequency (see diagram) in every step in the as-delivered state.

The setting signal (0 - 10 V) for every step and thus the output frequency can be reduced with the internal potentiometer.

The reduction acts on all steps (1 – 5) in percentage relation. It might therefore be possible to prevent interference noises caused by resonances at certain frequencies.

Potentiometer adjustable with a screwdriver

- Left stop: No reduction, i.e. output frequency e.g. in step 5 = 50 Hz (factory setting  diagram)
- Right stop: Maximum reduction 25 %, i.e. output frequency, e.g. in step 5 = 37.5 Hz)

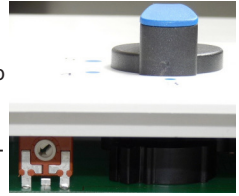

Potentiometer for step adaptation

The value of the output frequency can be checked with a suitable measuring instrument!



Danger due to electric current

- It is generally forbidden to carry out work on electrical live parts. Protection class of the device when open is IP00! It is possible to touch hazardous voltages directly.
- The device must have been disconnected from the line voltage for at least 3 minutes before opening!
- Observe the safety information!

5.6 Motor protection

Motor protection is possible by connecting thermostats “TB” or thermistors “TP”.

The jumper “J1” in the connection space must be plugged according to the used thermal protectors.

Motor with thermistors “TP”

For motor with thermistors “TP” jumper plugged at top (**factory setting**).

A maximum of six individual thermistors (DIN 44081 or DIN 44082) may be connected in series to a single device.



Motor with thermostats “TB”

For motor with thermostats “TB” the jumper “J1” must be plugged at the bottom.



When a connected thermostat or thermistor responds (interruption between the two terminals “TB/TP”) the device switches off and does not switch back on. Relais “K1” is de-energized, terminals “13” - “14” interrupted. The internal signal lamp flashes in code 15 (Diagnostics / faults).

Possibilities for re-starting after the drive has cooled down (terminals “TB/TP” bridged) by:

- By switching the mains voltage off and then on again.
- Via a digital input for remote control (ON/OFF enable).



Danger due to electric current

An outside voltage may never be connected to the terminals “TB/TP” and/or!

5.7 Voltage supply for external devices (+24V, GND)

A voltage supply is integrated for external devices e. g. a sensor (max. current load  technical data).

In case of overload or short circuit (24 V – GND), the external power supply is shut down (multi-fuse). The device performs a “Reset” and continues operation.

It is not permissible to connect outputs of several devices to each other!

5.8 Enable, Device ON / OFF (Digital In 1 = D1)

Electronic disconnection and Reset after motor fault via floating contact at terminals “D1”- “24V” (input resistance and voltage range  Technical data).

- Device “ON” for closed contact.
- Controller “OFF” with opened contact.

Activation via floating contacts, a low voltage of approx. 24 V DC is connected.



Danger due to electric current

- No disconnection (isolation) when turned off by remote, in accordance with VBG4 §6!
- Never apply line voltage to the digital input!

5.9 Relay outputs (K1)

An operating message or activation of a damper control motor is possible via the potential-free contacts of the relay “K1” (max. contact load  technical data and connection diagram).

At a modulation above 5 Hz the relay energizes, i.e. the terminals “13” and “14” are bridged.

At low modulation (below 3 Hz), switch off by the enable, switch off of line voltage or in case of a fault, the relay de-energizes.

5.10 Bypass circuit

Please observe the following during bypass switching (controller shunt with mains voltage):

- Mutual locking of mains contactor and bypass protection.
- Time delay of at least 1 second during switching.
- When the contactor is switched off at the inverter output, the “enable” (ON / OFF) must also be opened and closed again when it is switched back on. When switching off, wait at least 90 seconds before switching back on!
- Never apply line voltage to the inverter output!

5.11 Potential at control voltage connections

The control voltage connections (< 50 V) relate to the joint GND potential (Exception: Relay contacts are potential free). There is a potential separation between the control voltage connections and the protective earth. It must be ensured that the maximum external voltage at the control voltage connections cannot exceed 50 V (between “GND” terminals and “PE” protective earth). If necessary, a connection to the protective earth potential can be established, install bridge between “GND” terminal and the “PE” connection (terminal for screening).

6 Start-up

6.1 Prerequisites for commissioning



Attention!

1. You must mount and connect the device in accordance with the operating instructions.
2. Double check that all connections are correct.
3. The mains voltage must match the information on the rating plate.
4. The rated current on the rating plate will not be exceeded.
5. Make sure that no persons or objects are in the hazardous area.

7 Diagnostics / Faults

Operating conditions are indicated by the status LED with flashing code.

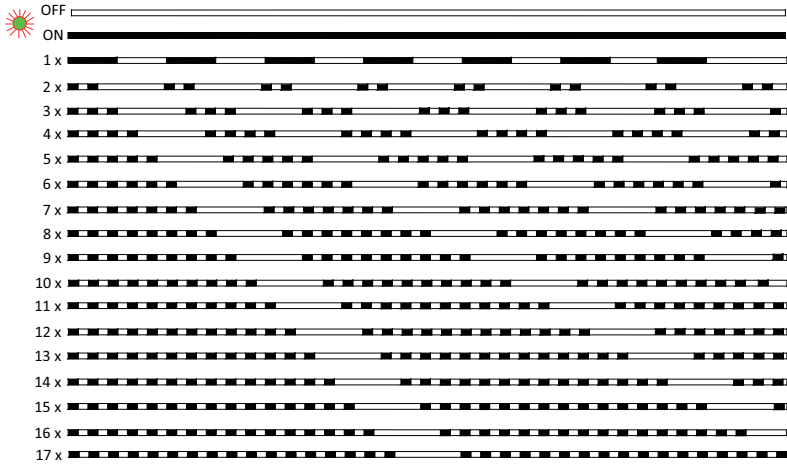

Code	Relay K1	Explanation	Reaction of Controller
			Adjustment
OFF	de-energized, 13 - 14 interrupted	No line voltage	In the event of a mains interruption the unit switches "OFF" and automatically "ON" when the voltage has been restored. Check line voltage and pre-fusing.
ON	Energized at modulation above 5 Hz (terminals 13 - 14 bridged). De-energized at modulation below 3 Hz (13 - 14 interrupted).	Normal operation without fault	

Code	Relay K1	Explanation	Reaction of Controller
			Adjustment
1	de-energized, 13 - 14 interrupted	No enable = OFF Terminals "D1" - "24 V" (Digital In 1) not bridged.	Switch off by external contact (☞) enable, device ON / OFF.
2	Energized at modulation above 5 Hz (terminals 13 - 14 bridged). De-energized at modulation below 3 Hz (13 - 14 interrupted).	Active temperature management The device has an active temperature management to protect it from damage due to too high inside temperatures. In case of a temperature rise above the fixed limits, the modulation is reduced linearly. To prevent the complete system being switched off externally (in this operation permissible for the controller) in case of reduced operation due to too high an internal temperature, no fault message is sent via the relay.	With a drop in temperature the modulation rises again linearly. Check cooling of the controller
4	de-energized, 13 - 14 interrupted	line failure The device is provided with a built-in phase-monitoring function for the mains supply. In the event of a mains interruption (failure of a fuse or mains phase) the unit switches off after a delay (approx. 15 s). Only functioning with an adequate load for the controller.	Following a shutoff, a startup attempt is made after approximately 5 seconds, if the voltage supply is high enough. This keeps occurring until all 3 supply phases are available again. Check line voltage.
6	de-energized, 13 - 14 interrupted	IGBT Fault Earth fault or short-circuit at inverter output.	The device switches off, renewed attempt to start after about 60 s (☞) Code 9. Final switch off when error is detected after the third start attempt at an interval < 60 s. Reset by enable or line voltage ON/OFF.
7	de-energized, 13 - 14 interrupted	DC over voltage Intermediate circuit voltage below a fixed limit for longer than 75 s.	The modulation is switched off immediately at undervoltage, error message after 75 s. Automatic switching back on and switching off of error message when the voltage exceeds the fixed limit for at least 5 s. Check line voltage.

Code	Relay K1	Explanation	Reaction of Controller
			Adjustment
8	de-energized, 13 - 14 interrupted	DC over voltage Intermediate circuit voltage above fixed limit for longer than 75s. Reason for excessively high line voltage or alternator motor operation.	The modulation is switched off immediately at overvoltage, error message after 75 s. Automatic switching back on and switching off of error message when the voltage drops below the fixed limit for at least 15 s. Check line voltage. Prevent generator motor operation.
9	de-energized, 13 - 14 interrupted	IGBT cooling down period IGBT cooling down period for approx. 60 sec.	Final shutoff after 2 cooling-off intervals ☞ Code 6.
12	de-energized, 13 - 14 interrupted	Line voltage too low Line voltage below a fixed limit for longer than 75 s.	The modulation is switched off immediately at undervoltage, error message after 75 s. Automatic switching back on and switching off of error message when the voltage exceeds the fixed limit for at least 5 s. Check line voltage.
13	de-energized, 13 - 14 interrupted	Line voltage too high Line voltage above fixed limit for longer than 75 s.	The modulation is switched off immediately at overvoltage, error message after 75 s. Automatic switching back on and switching off of error message when the voltage drops below the fixed limit for at least 15 s. Check line voltage.
14	de-energized, 13 - 14 interrupted	Error Peak current If the output current increases above the specified limit (even in a short time-frame) the device will switch-off.	After a switch off the controller waits for 30 seconds then the controller attempt a start. If 10 switch offs take place consecutively within 60 s (time to next respective error), final switch off takes place with an error message. Should no further switch off be exceeded in 90 sec. the counter will be reset.
15	de-energized, 13 - 14 interrupted	Motor fault A connected thermostat or thermistor has tripped the circuit or interruption between both terminals "TB / TP". Plug for "TB" or "TP" in wrong position.	The unit cuts out and does not switch on again. Check motor and connection then reset (☞ Motor protection).

Code	Relay K1	Explanation	Reaction of Controller
			Adjustment
16	de-energized, 13 - 14 interrupted	Sine filter to hot (only in version with integrated sine filter)	Switch off at to high temperature, restarting after cooling down. Check temperature in controller, Check cooling of the controller.
17	de-energized, 13 - 14 interrupted	Overload fault The controller was switched off by the current limitation.	The error is set after detecting 4 times (I^2t -process; maximum overload applied for 60 s). After every detection (IGTB Recovery Flag is set) there is a 30 s wait until a new attempt is started. The respective errors must always have a shorter interval than 5 minutes (started after restart). The modulation is switched off immediately after every detection. Check load of the device. Reset by enable or line voltage ON/OFF.

8 Enclosure

8.1 Technical data

Type	FRQ5S-4A	FRQ5S-10A	FRQ5S-16A
Part-No.	36233 (308278-42)	36234 (308279-42)	37276 (308301-42)
Rated current output {1}	4 A	10 A	16 A
Rated current input {2} (I fundamental component @ 50 Hz)	3.8 A (3.5 A)	9.4 A (8.6 A)	15.2 A (14.0 A)
Recommended motor output {3}	1.5 kW	4.0 kW	7.5 kW
Max. line fuse {4}	10 A	16 A	20 A
Max. leakage current according to the dened networks of DIN EN 60990 (depending on connected line voltage *)	< 3.5 mA	< 3.5 mA	< 3,5 mA @ < 480 V * ≥ 3,5 mA @ ≥ 480 V *
Max. heat dissipation approx. {2}	80 W	200 W	360 W
Rated temperature	55 °C	40 °C	40 °C
Weight	5.5 kg	6.4 kg	7.1 kg

- {1} Rated current output Δ current indication rating plate @ rated voltage, @ rated temperature (cos φ 0.8 at the output)
- {2} At rated voltage (cos φ 0.8 at the output), values for different specifications on request.
- {3} Example for power of a 4 pole motor. For the dimension of the frequency inverter size the rated current of the motor is crucial!
- {4} Max. supply side line fuse according to DIN EN 60204-1 classification VDE0113 chapter 1

Line voltage*	3 ~ 208...480 V (-15 bis +10 %), 50/60 Hz
Rated voltage	400 V
Maximal output voltage	approx. 95 % from U_{line}
Maximal output frequency	50 Hz
Edgefrequency	48,5 Hz
U/f-characteristic curve	square
Switching frequency	16 kHz
Rampup time	20 sec
Rampdown time	20 sec
Current limit	FRQ5S-4A: 120 %, FRQ5S-10A: 110 %, FRQ5S-16A: 120 %
Power factor	> 0.9
Voltage supply for external devices	+24 V \pm 20 %, I_{max} 70 mA
Heat dissipation in standby operation	approx. 3 W
Digital input "D1"	Input resistance: R_i approx. 4 k Ω Voltage range high level: 10...30 V DC Voltage range low level: 0...4 V DC

Max. contact rating of the internal relay	2 A / 250 V AC
Max. permissible ambient temperature	55 °C
Min. permissible ambient temperature	0 °C (if mains voltage is not switched off up to -20 °C) To avoid condensation the device must be continuously energized due to the application of heat, with interruptions such that cooling to the point of condensation does not occur.
Permissible temperature range for storage and transport	-30...+80 °C
Max. permissible installation height	0...4000 m amsl above 1000 m amsl the rated current is to be reduced by 5 % / 1000 m
Permissible rel. humidity	85 % no condensation
Electromagnetic compatibility for the standard voltage 230 / 400 V according to DIN IEC 60038	Interference emission EN 61000-6-3 (domestic household applications)
	Interference immunity EN 61000-6-2 (industrial applications)
Harmonics current	According EN 61000-3-2 for a "professional unit" ☞ Electrical installation / harmonics current
	Please ask manufacturer for the individual harmonic oscillation levels of the current as a percentage of the fundamental oscillation of the rated current.
Vibratory strength (for vertical installation, i.e. cable inlet down).	Broadband noise (simulated life-endurance test) in accordance with EN 61373, category 1 class B. Shock test according to EN 61373, category 1
Max. cross section/diameter of the conductors for line and motor connection	Conductor cross section single-wire: 4 mm ² Conductor cross-section fine-wire: 4 mm ² , with wire end ferrule 2.5 mm ² Conductor (AWG): 12
Housing protection	IP54

* *Regarding the mains connection, these devices are to be classified as category "C2" devices according to the relevant DIN EN 61800-3. The increased requirements placed on electrical interference > 2 kHz for category "C1" devices are complied with in addition.*

8.1.1 Max. load dependent on ambient temperature and line voltage.

The maximum permissible temperature for the rated current at rated voltage is specified as rated temperature.

Since the dissipation of the power loss (heat development) in the device is decisively dependent on the ambient temperature, the max. load must be reduced at an ambient temperature above the rated temperature (☞ following table)!

The average value measured during a 24 h period must be 5 K under the max. ambient temperature. For installation in a switch cabinet, the device's dissipation and its possible affect on the ambient temperature must be taken into consideration!

Since the power loss in the device increases with rising line voltage, the following table must be observed.

Maximal load depending on line voltage and ambient temperature						
	208 V (-15 %)...415 V (+6 %)			over 415 V (+6 %)...480 V (+10 %)		
Type	40 °C	50 °C	55 °C	40 °C	50 °C	55 °C
FRQS(5)-4A	4.0 A	4.0 A	4.0 A	4.0 A	4.0 A	4.0 A
FRQS(5)-10A	10.0 A	8.0 A	7.0 A	9.5 A	7.5 A	7.0 A
FRQS(5)-16A	16.0 A	13.0 A	11.0 A	14.5 A	11.5 A	9.5 A

8.2 Connection diagram

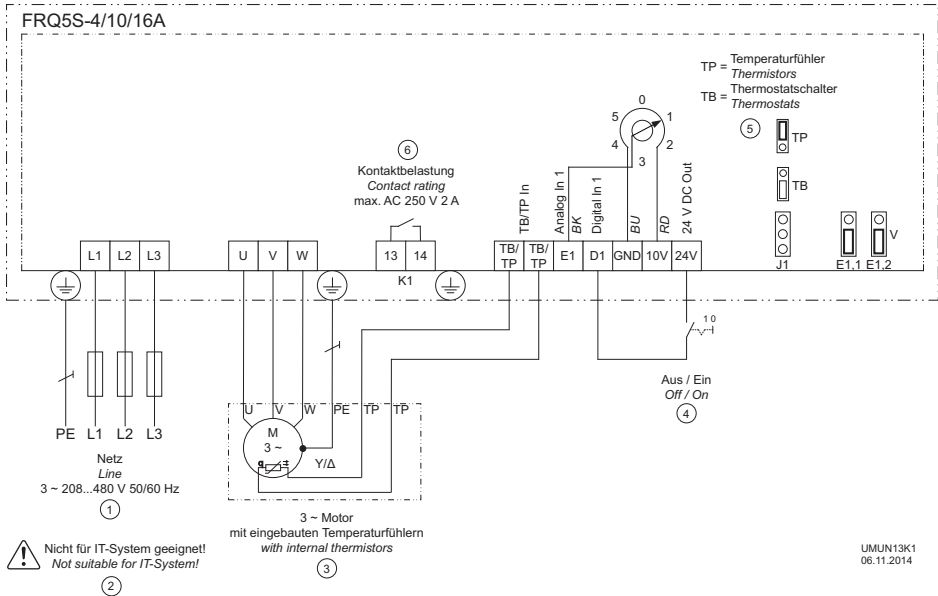

- 1 Line 3 ~ 208 V...480 V, 50/60 Hz
- 2 Not suitable for IT system!
- 3 ~ Motor with internal thermistors
- 4 Enable Device Off / On
- 5 TP = thermistors, TB = thermostats
- 6 Contact rating max. 2A / 250 V AC

8.2.1 Connection suggestion for several motors with motor protection unit type STDT

- Full motor protection by switch-off when activating the attached thermostat switches "TB". Reset after malfunction by key press.
- Line protection: A thermal over current sensor and a magnetic short circuit releasing elements are the parts of the integral line protection. Adjustment to the thermal overcurrent sensor to the max. permissible current of the connected cable (max. line fuse 80 A).
- No cut-off if the mains supply is interrupted

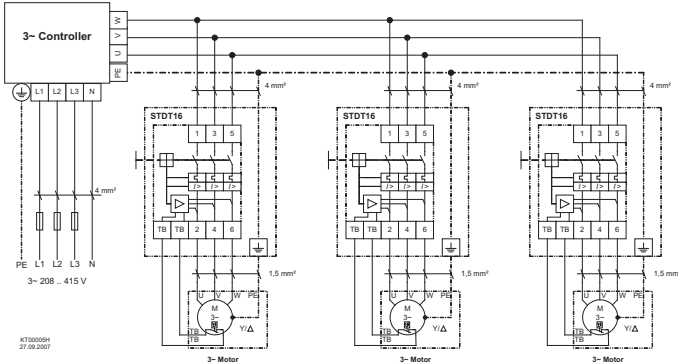

Consider max. terminal load Operating Instructions!
 (General example, data for the connection of the controller dependent on the used type of device)

8.3 Dimensions [mm]

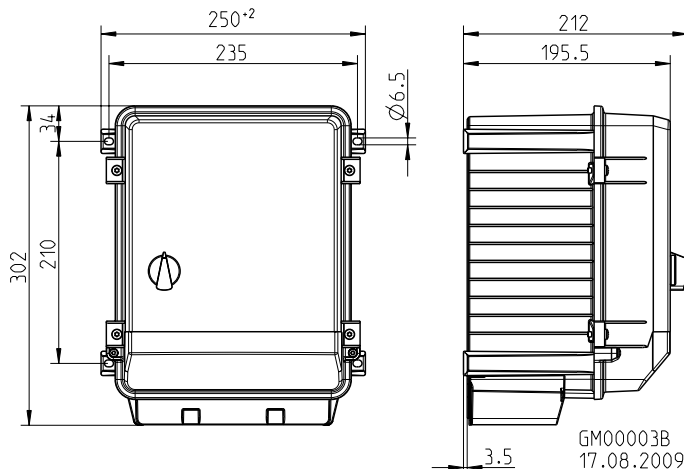

Representation of the switch position subject to change!

8.4 Manufacturer reference 

Our products are manufactured in accordance with the relevant international regulations. If you have any questions concerning the use of our products or plan special uses, please contact:

Systemair
Industrievägen 3
73930 Skinnskatteberg
Telefon:+46 (0) 222 440 00
Telefax:+46 (0) 222 440 99
mailbox@systemair.se
www.systemair.se