

Technical Data Sheet

CODE 42347

A-E 636 T

Compact plate axial fans



Certifications

CE CE

EAC EAC

TECHNICAL AND PERFORMANCE DATA

Frequency (Hz)	50	Voltage (V)	380-415
Insulation class	I°	Weight (Kg)	15,8
IP	54	Max airflow (l/s)	2639
Max absorbed current (A)	1,10	Max airflow (m³/h)	9502
Max absorbed power (W)	522	Max pressure (Pa)	154
Max ambient temperature for continuous operation (°C)	50	Max pressure at Max speed (mmH2O)	15,7
Motor ATEX marking	54	RPM	1000
Nominal diameter (mm)	630	Sound power Lw [dB(A)]	78,5
Number of phases (Ph)	3	Sound pressure at 1m calculated in free field Lp [dB(A)]	67,5
Number of poles	6	Sound pressure at 3m calculated in free field Lp [dB(A)]	58,0

DIMENSIONS

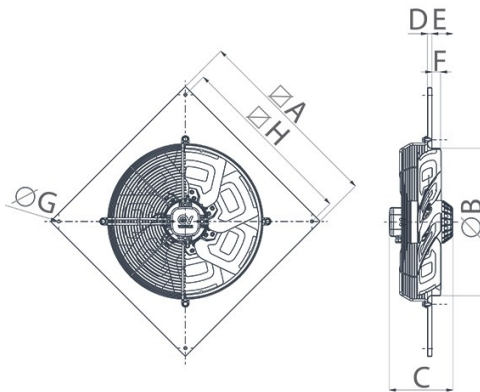

Size A (mm)	805
Size B (mm)	638
Size C (mm)	218
Size D (mm)	15
Size E (mm)	68
Size F (mm)	45
Size G (mm)	11
Size H (mm)	750

PER INFORMAZIONI / FOR INFORMATION

ITALY

Pre Sales:
prevendita@vortice-italy.com
After Sales:
postvendita@vortice-italy.com

UNITED KINGDOM & REP. OF

IRELAND
Sales Dept:
sales@vortice.ltd.uk
Technical Dept:
technical@vortice.ltd.uk

OTHER COUNTRIES

Sales Dept:
export@vortice-italy.com
After Sales:
after-sales@vortice-italy.com

Technical Data Sheet

CODE 42347

A-E 636 T

Compact plate axial fans



DESCRIPTION

- Nominal diameter 630 mm
- Panels made of pressed steel, phosphated and epoxy powder coated with hammered effect finish, guaranteeing long-term resistance to atmospheric agents.
- Ventilation port fashioned in one piece with the panel, gauged to optimize air flow, aerodynamically contoured and elongated to optimize performance and facilitate connection to the relative duct.
- Protective grille (in accordance with UNI ISO 13857 standard) combining the function of motor bracket, made of electrically welded steel with epoxy paint finish, colour black. Easy removal simplifies

maintenance and cleaning of the fan.

- 1 speed three-phase AC motor of external rotor type designed to minimize axial dimensions, with shaft turning in ball bearings, insulation class F, thermal overload protection.
- Dynamically balanced impeller (UNI ISO 1940, Point 1 – Class 6.3); 4 pressed steel blades, electrolytically galvanized and polyester powder-coated, colour black.
- Vortice speed controller.

CURVES

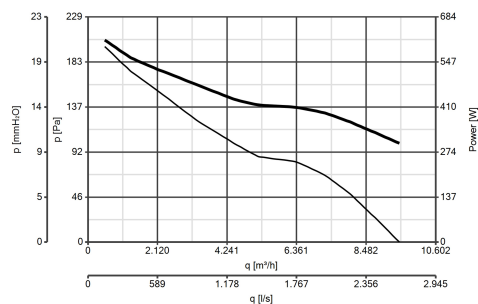

ACCESSORIES



IRT 35

Code 12924



IRET INVERTER

2,5 M

Code 12816

PER INFORMAZIONI / FOR INFORMATION

ITALY

Pre Sales:

prevendita@vortice-italy.com

After Sales:

postvendita@vortice-italy.com

UNITED KINGDOM & REP. OF

IRELAND

Sales Dept:

sales@vortice.ltd.uk

Technical Dept:

technical@vortice.ltd.uk

OTHER COUNTRIES

Sales Dept:

export@vortice-italy.com

After Sales:

after-sales@vortice-italy.com